

0 601 370 703

Issue } 03-01-21  
Stand }

**Fig./Abb. 2**

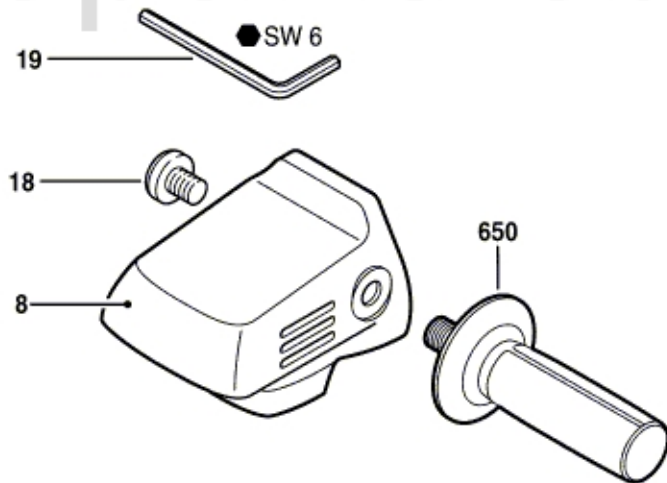
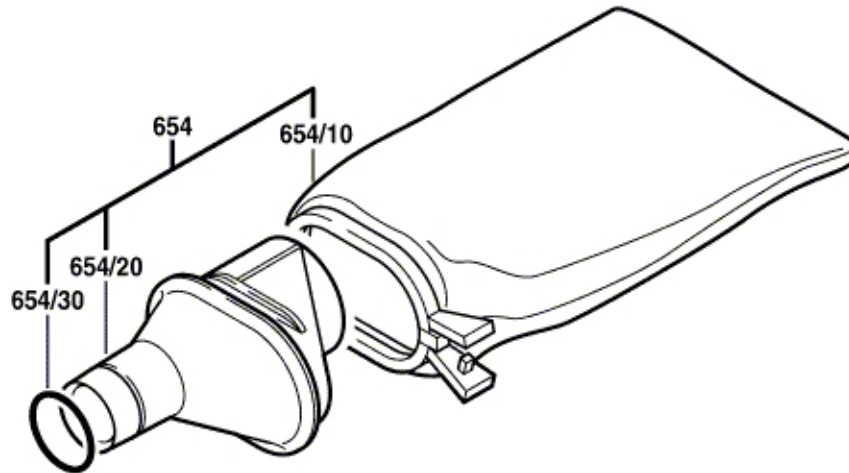
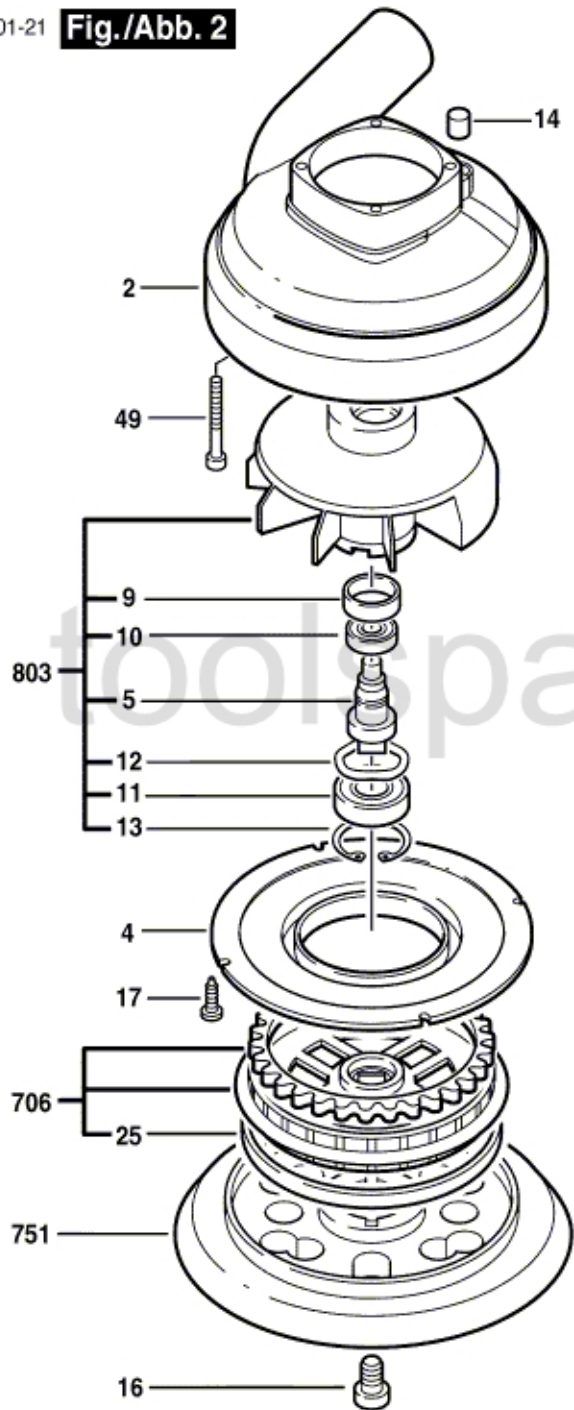

Modifications reserved  
Änderungen vorbehalten  
Modifications réservées  
Salvo modificaciones